

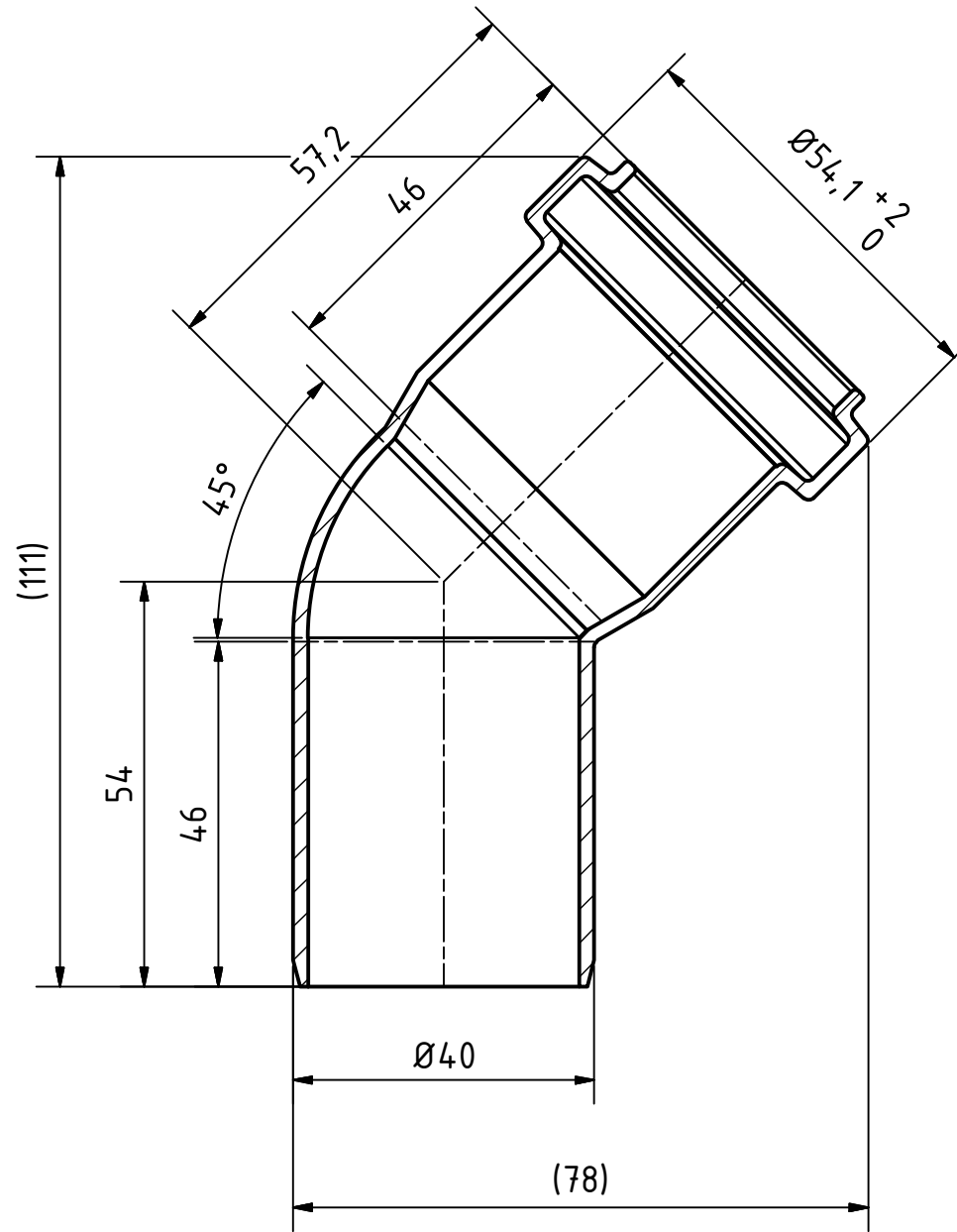

A-A (1 : 1)



		Maße nach DIN EN 1451-1		Art.Nr.: 171120		Maßstab 1:1		
				Material: PP-H schwerentflammbar				
		Datum		Name		<h1>HT Safe</h1>		
		Gezeichnet 29.09.2016		A.Schmedes				
		Kontroll.						
Status	Änderungen	Datum	Name	Norm				
Gebr. Ostendorf Kunststoffe GmbH Rudolf-Diesel-Str. 6-8 D-49377 Vechta verkauf@ostendorf-kunststoffe.com www.ostendorf-kunststoffe.com						HTsafeB Bogen DN/OD 40/45°		1
								Schutzvermerk nach DIN ISO 16016 beachten!